

NAŠ ČEBELNJAK

TIP »B«
za 17 AŽ panjev

avtor:
Marjan Debelak, dipl. inž. arh.

Ljubljana, dec. 1999

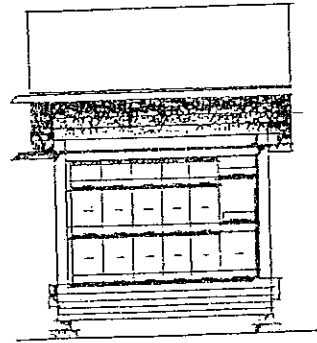

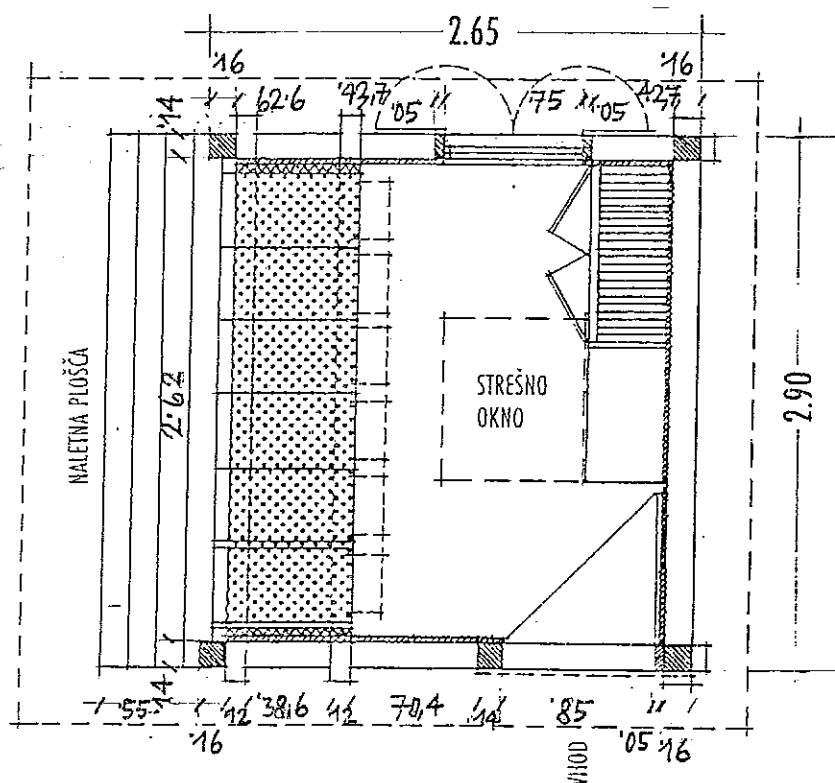
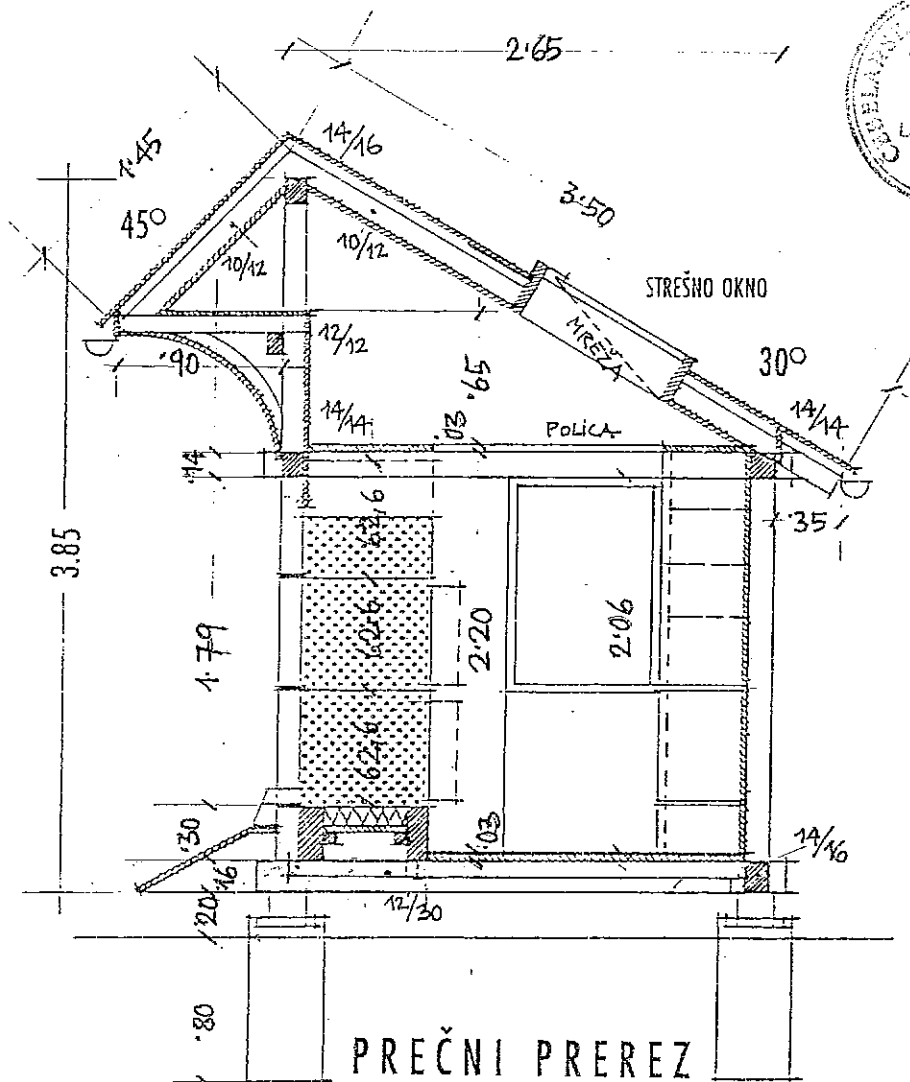

TLORIS

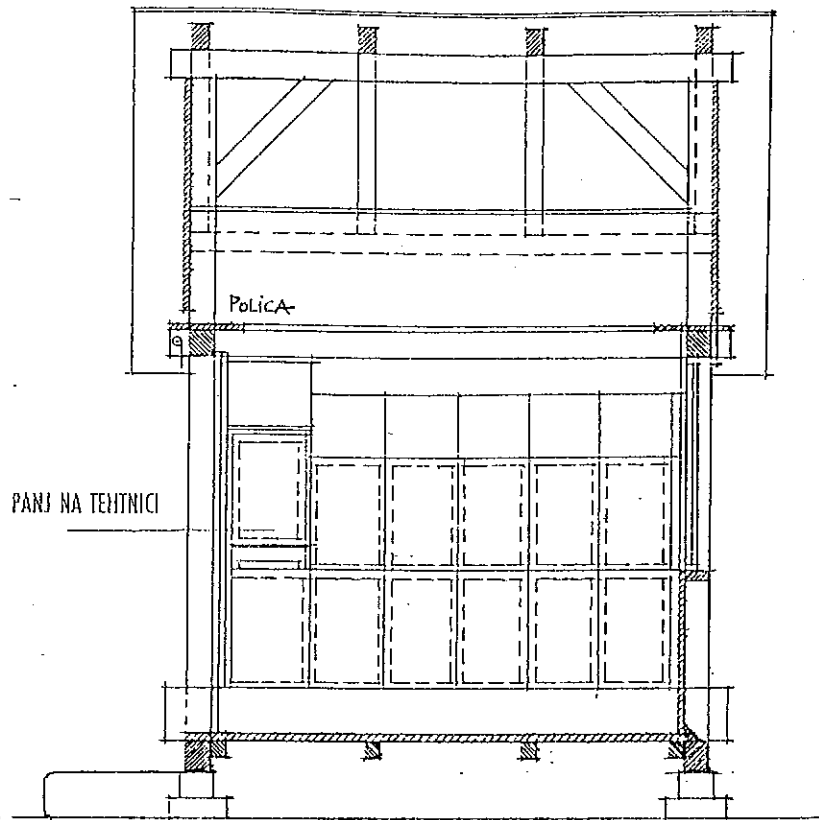

VZDOLŽNI PREREZ

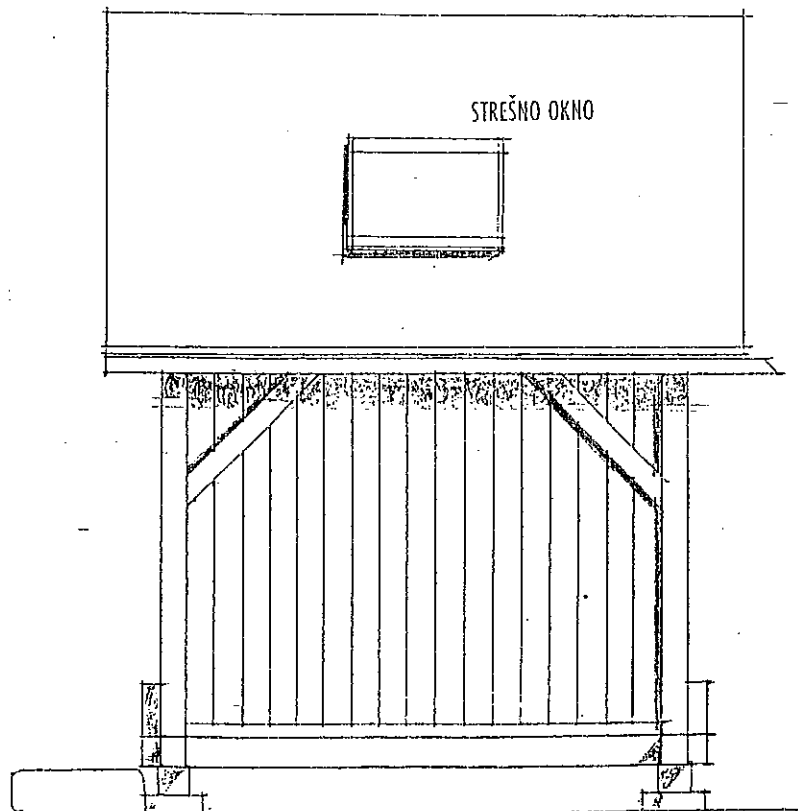

SEVERNA FASADA

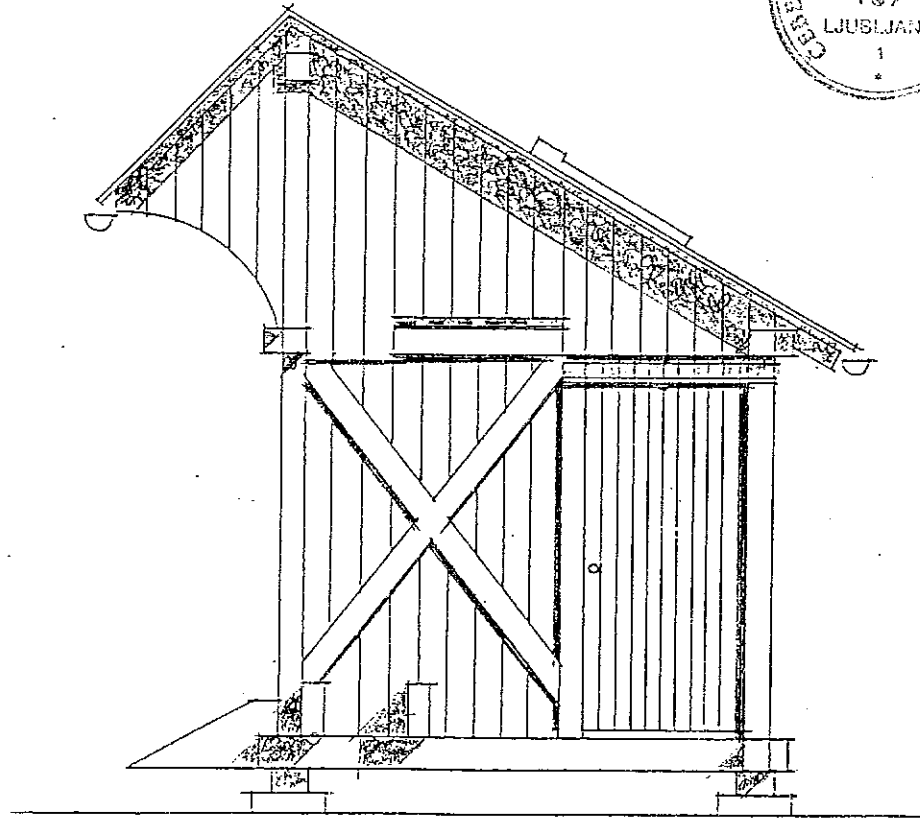

VHODNA FASADA

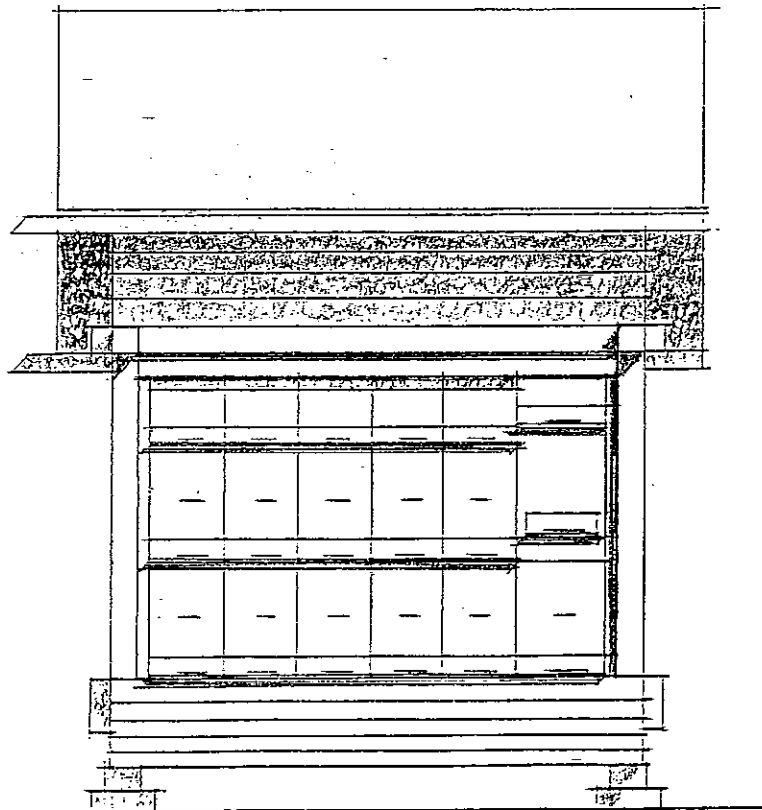

JUŽNA FASADA